

DACIA

# DACIA SANDERO STEPWAY



2nd July 2024

1

## EXPLORE YOUR SANDERO STEPWAY

DISCOVER



2

## YOUR SANDERO STEPWAY FOR DAILY USE

DISCOVER



3

## EQUIPMENT AND TECHNICAL CHARACTERISTICS

DISCOVER



4

## THE DACIA SPIRIT: PURE AND SIMPLE

DISCOVER



# SIMPLY ESSENTIAL



# TAKING A BREAK EVERY DAY

Dacia Sandero Stepway reaffirms its crossover style: take escapism to the next level thanks to the EXTREME finish, which gives the vehicle an even stronger off-road look.



# A SENSE OF ADVENTURE

A single glance and you are already itching to escape with Dacia Sandero Stepway. Its sculpted bonnet, bold front end, protective features and high ground clearance give it the dynamic and robust style of an authentic crossover. Its LED headlights, Y-shaped brand light and glossy black grille give it even more character.



Live the adventure thanks to its EXTREME finish with an even more prominent outdoor spirit: Copper door mirrors, alloy wheels and Glossy Black shark fin antenna. A unique style topped with distinctive elements featuring topographical patterns to better identify it. And with Extended Grip, improved traction to get off the beaten track.



**Brand light**



**Extended Grip button**



## WELL-DESIGNED COMFORT

All the technologies you need: climb aboard effortlessly thanks to keyless entry, and discover the style of the new passenger compartment. In the EXTREME finish, the interior features new, easy to clean, mixed TEP MicroCloud plastic-coated fabric upholstery, with a soft-touch velvet appearance also present on the instrument panel and armrests. The Copper touches and topographic lines featured on the rubber floor mats complement the vehicle's unmistakable outdoor spirit.

In terms of equipment, enjoy the height- and depth-adjustable seats and steering wheel, the electric parking brake and a closed storage space in the armrest: practicality and comfort combined. Connect your smartphone and use your preferred applications on the 8-inch touch screen. The controls, all placed within easy reach, provide maximum ease of access to all functions.

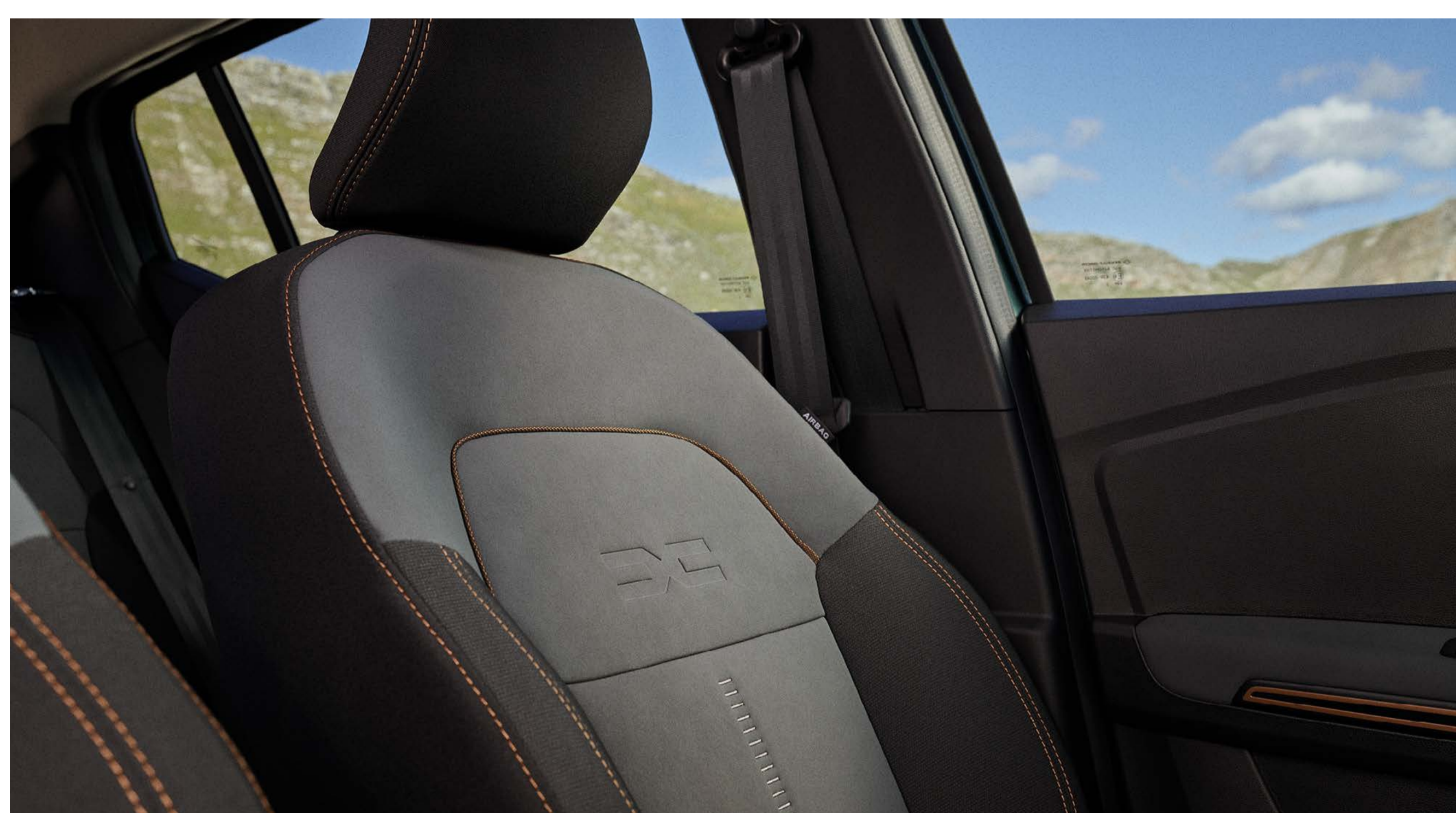

**Special upholstery**



**8-inch touch screen with Media Nav**

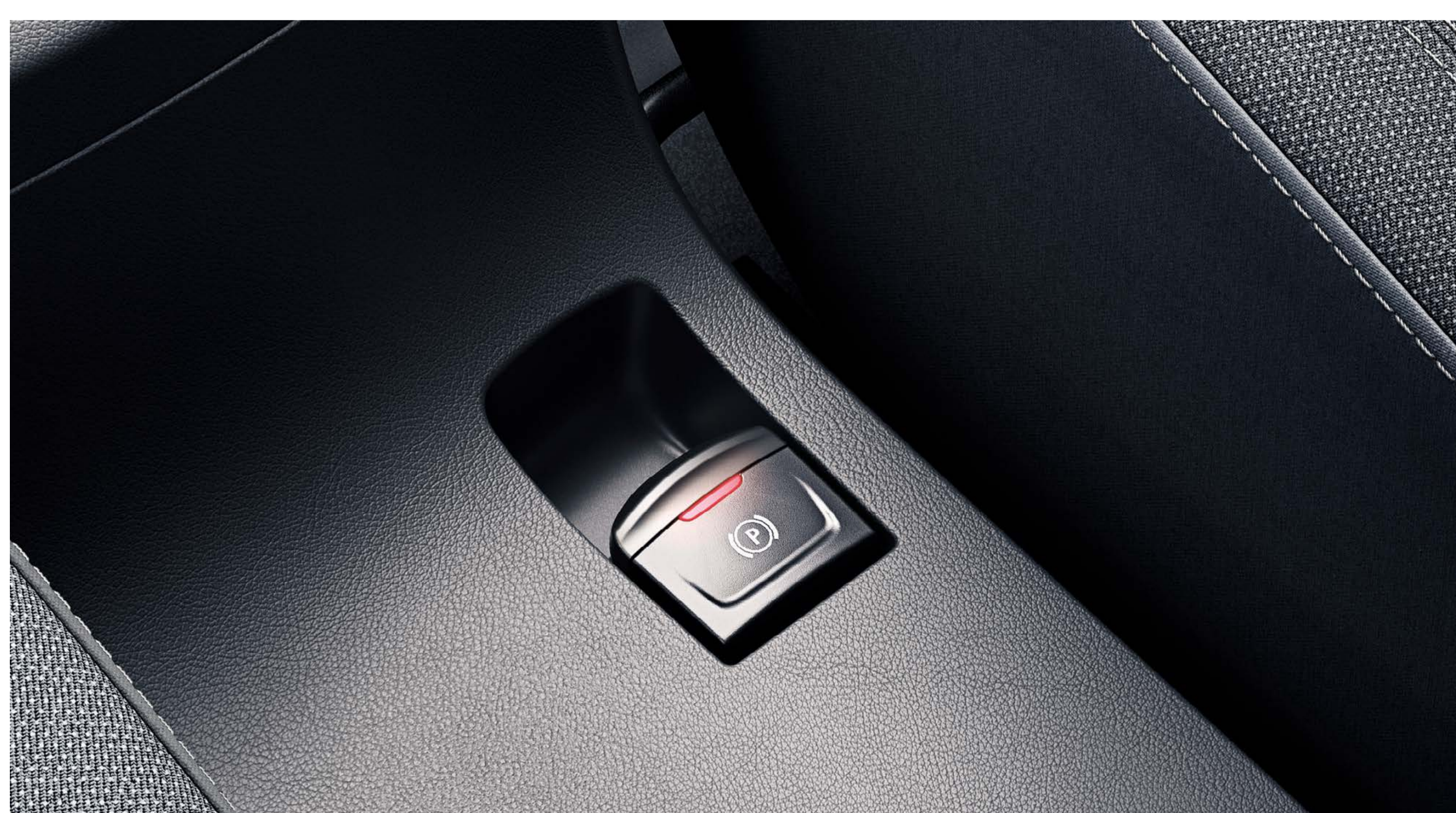

**Electric parking brake**

[BUILD YOURS](#)

[BACK TO CONTENTS](#)

# VERSATILE CROSSOVER

Dacia Sandero Stepway rises to the challenge of real life: thanks to its large flexible luggage area, switch from city life to adventure in a flash. And still benefit from the latest features that allow you to drive with complete peace of mind.



\*Sunroof not available in the UK

# THE SPACE YOU NEED TO FIT ALL YOUR WISHES

Fold down the seats with a single touch, adjust the loading capacity as required and live life to the full.



\*Sunroof not available in the UK

Thanks to an ingenious system, effortlessly convert the modular roof bars into a roof rack, ready to fit a roof box, a bicycle rack or a ski rack. Ready to take on the world? Let's go!



**Modular roof bars**



# SAFE EVERY STEP OF THE WAY

For Dacia, nothing is more important than constantly improving the safety of our vehicles, and most of all, that of the passengers. What with automatic emergency braking, hill start assist, six airbags (standard) and blind spot sensor, you can relax. Dacia Sandero Stepway provides everything you need for worry-free driving.



## **AUTOMATIC EMERGENCY BRAKING (AEB) WITH PEDESTRIAN/CYCLIST DETECTION**

This system prevents the risk of head-on collisions involving other vehicles, pedestrians or cyclists in a straight line or at junctions. It alerts the driver and can automatically brake the vehicle if necessary.

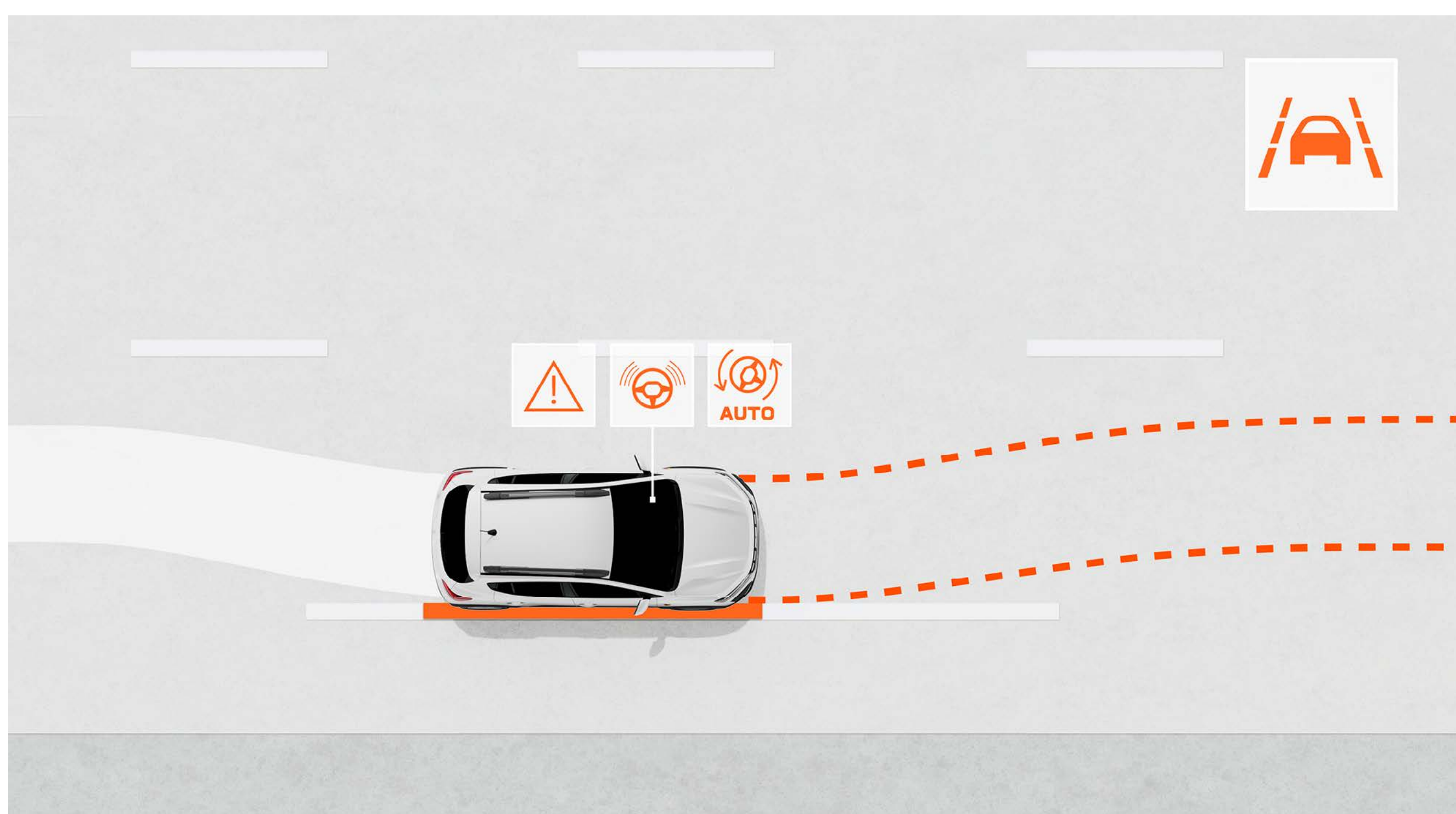

## **LANE KEEPING ASSIST**

Monitors the vehicle's path in its lane and corrects it if necessary by automatically adjusting the steering.



## **DRIVER ATTENTION ALERT**

Warns the driver if fatigue is detected by analysing several parameters, including steering wheel movements, to encourage him or her to take a break.

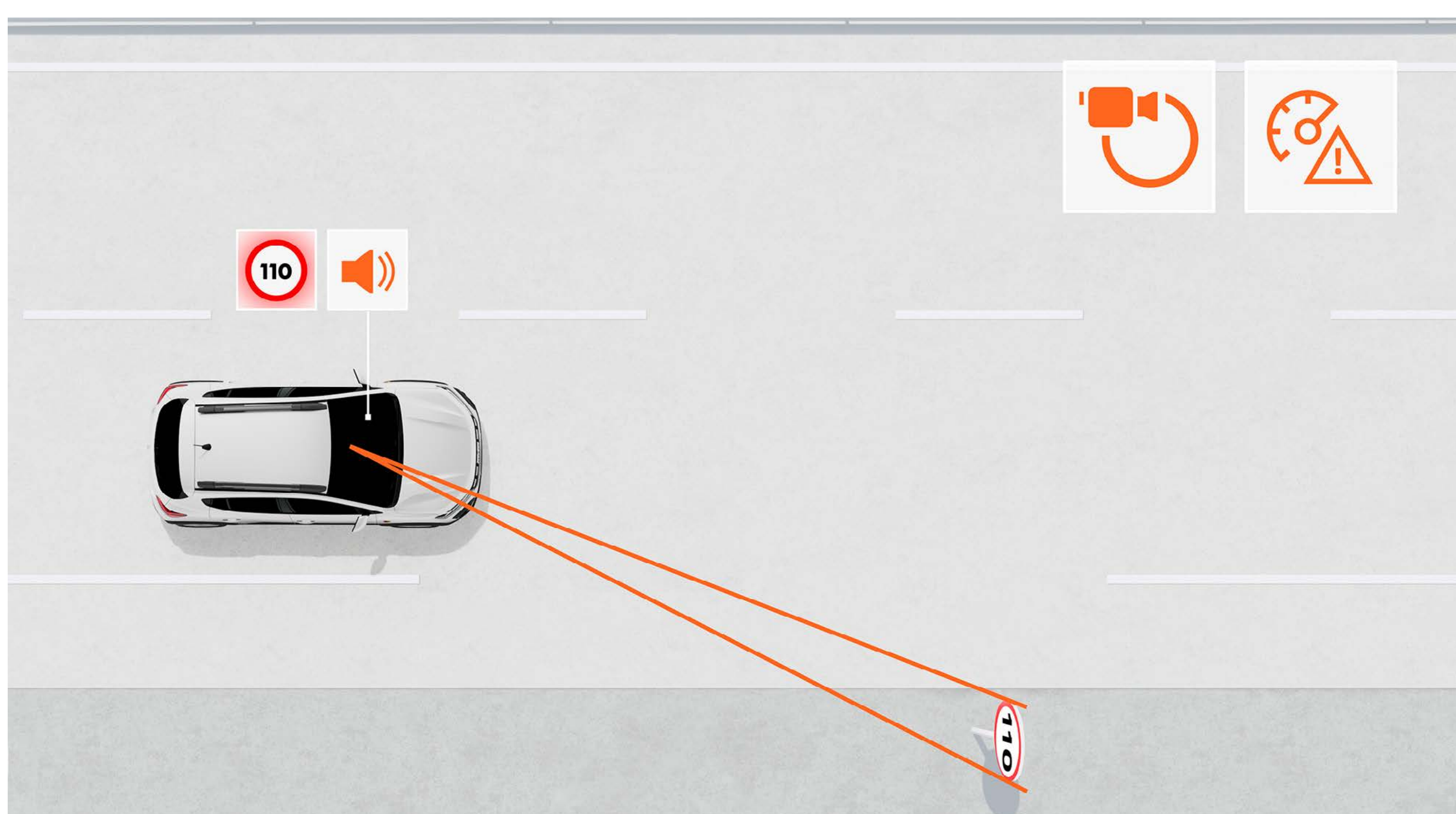

## **TRAFFIC SIGN RECOGNITION WITH SPEED ALERT**

Provides a highly reliable, real-time indication of the maximum speed on the road ahead and warns the driver if the speed limit is exceeded with visual and audible alerts (which can be switched off).

[BUILD YOURS](#)

[BACK TO CONTENTS](#)

# FIND OUT MORE ABOUT OUR EQUIPMENT

BODY-COLOUR PALETTE



WHEEL TRIMS AND WHEELS



TRIMS



ACCESSORIES



ENGINES



EQUIPMENT AND OPTIONS



PRICING



SERVICING



DIMENSIONS



# BODY-COLOUR PALETTE

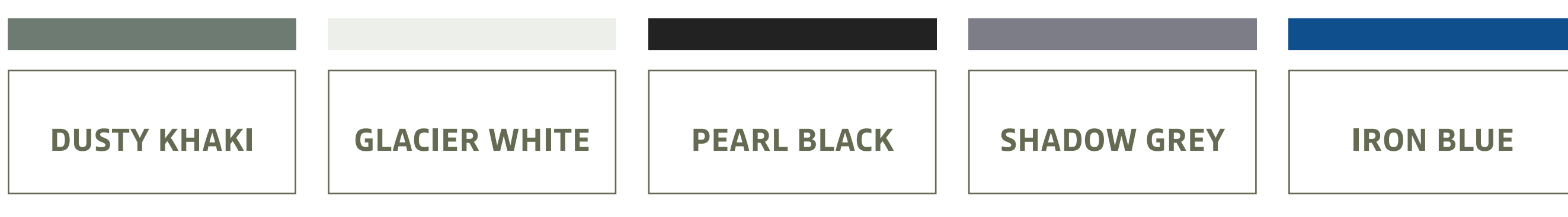

DUSTY KHAKI<sup>(1)</sup>



GLACIER WHITE<sup>(1)</sup>



PEARL BLACK<sup>(2)</sup>



SHADOW GREY<sup>(2)(3)</sup>



IRON BLUE<sup>(2)</sup>



SAFARI BEIGE<sup>(2)</sup>



CEDAR GREEN<sup>(2)</sup>

(1) Opaque paint. (2) Metallic paint. (3) Special paint.  
Photos are not contractually binding.

COLOUR AVAILABILITY		Essential	Expression	Extreme
<b>SOLID PAINT</b>				
369	Glacier White	○	○	○
<b>METALLIC PAINT</b>				
676	Pearl Black	○	○	○
KQG	Shadow Grey	○	○	○
DQK	Cedar Green	-	○	○
RQH	Iron Blue	-	○	○
HNY	Safari Beige	-	○	○
<b>SPECIAL PAINT (PRICED AS METALLIC)</b>				
KQM	Dusty Khaki	-	○	○

○ = Optional. - = Not available.

# WHEEL TRIMS AND WHEELS



ATARA DARK 16" FLEXWHEEL



16" MAHALIA BLACK ALLOY WHEEL

# TRIMS

## ESSENTIAL

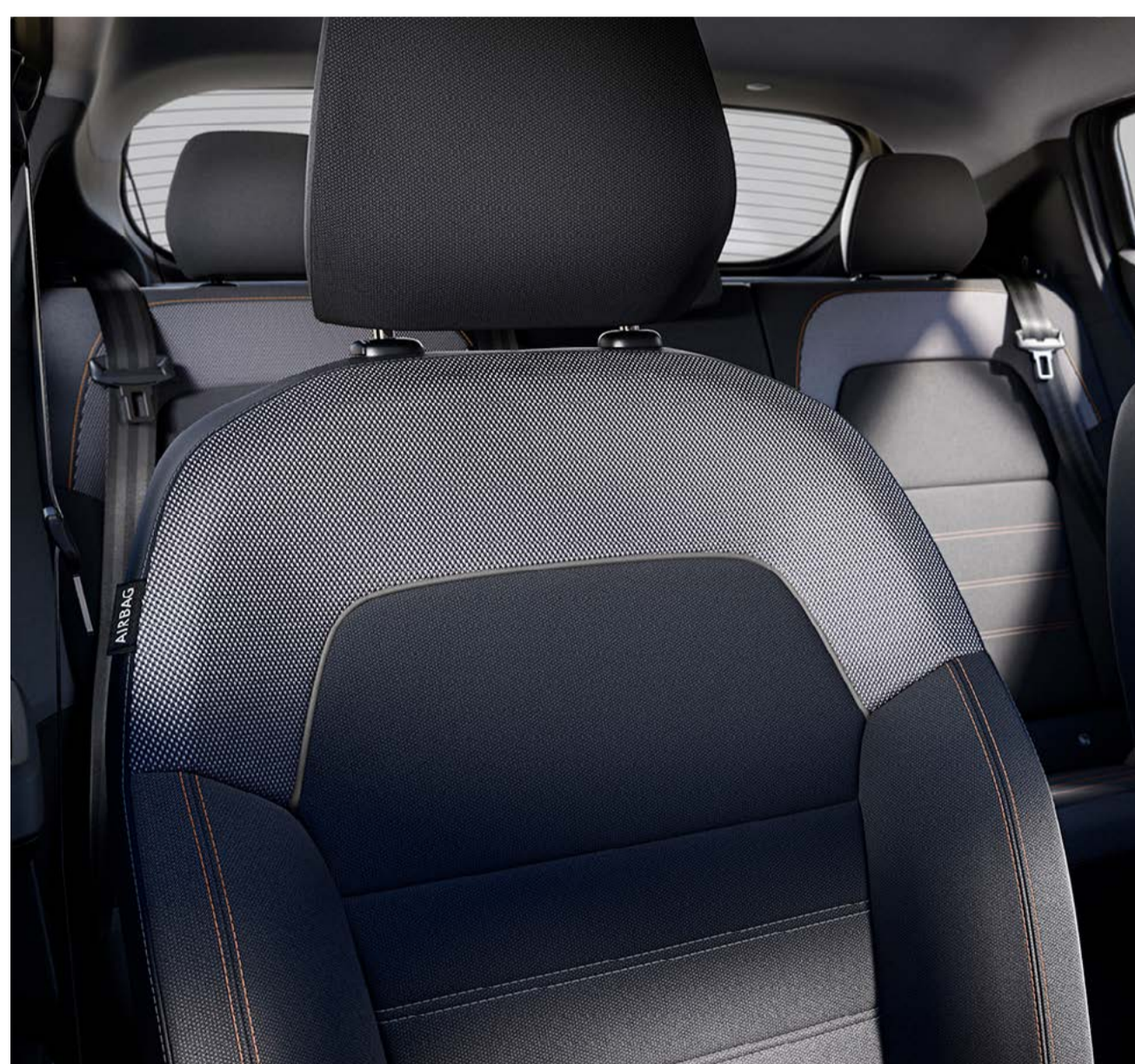

## MAIN EQUIPMENT

### EXTERNAL APPEARANCE

- Black grille with Dacia logo and white Stepway inscription
- LED signature light
- Automatic LED daytime running lights
- 16" Atara Dark Flexwheels
- Body-coloured front/rear bumpers
- Megalith Grey front/rear skid plates
- Black exterior door handles
- Black door mirrors
- Modular longitudinal roof bars (Megalith Grey)

### INTERIOR DESIGN

- Black air vent surrounds with orange centre
- Black interior door handles
- Rear bench with 1/3-2/3 folding and split function
- Specific stepway upholstery with contrast stitching

### ACTIVE AND PASSIVE SAFETY

- "My Safety" button to manage driving aids
- Anti-lock Braking System (ABS) and Emergency Brake Assist (EBA)
- Automatic emergency braking (AEBS) with pedestrian/cyclist detection
- Electronic Stability Control (ESC) with Hill Start Assist (HSA)
- Emergency call (E-call)
- Event (accident) data recorder
- Alcohol immobiliser predisposition
- Traffic sign recognition with speed alert/Intelligent Speed Assist (ISA)
- Lane Departure Warning (LDW) + Lane Keep Assist (LKA)
- Driver attention alert
- Front/rear "Rescue Code®" QR Code
- Driver's front airbag/deactivatable passenger front airbag
- Shoulder and curtain side airbags
- Rear parking sensors
- Tyre pressure monitor
- Tyre inflation kit
- Isofix child seat mounting system on rear outer seats
- Front and rear lateral seat belts with pre-tensioner and load limiter

### DRIVING AND CONTROL INSTRUMENTS

- Electrical power-assisted steering
- Stop & Start, ECO Mode
- On-board computer: distance travelled, average speed, range, average consumption (including LPG for Bi-Fuel versions)
- Rain and light sensors
- Cruise control and speed limiter with audible warning

### VISIBILITY

- Door mirrors with interior manual adjustment

### COMFORT

- Manual heating and air conditioning system
- Electric door locking with radio frequency remote
- Automatic door locking when driving
- Electric front windows
- Height-adjustable steering wheel
- Front ceiling light
- 1 x 12V socket in the front

### MULTIMEDIA AND AUDIO

- New Media Control: DAB radio with steering wheel controls, 1 USB-C socket, 2 speakers, Bluetooth® connectivity with side controls on the steering wheel, fixed smartphone holder on the dashboard, new Dacia Media Control smartphone application.
- 1 USB socket in the front

### OPTION

- Spare wheel + jack (Not available on Bi-Fuel version)
- Paint colours available in Glacier White (solid), Pearl Black (metallic), and Shadow Grey (metallic)

## EXPRESSION

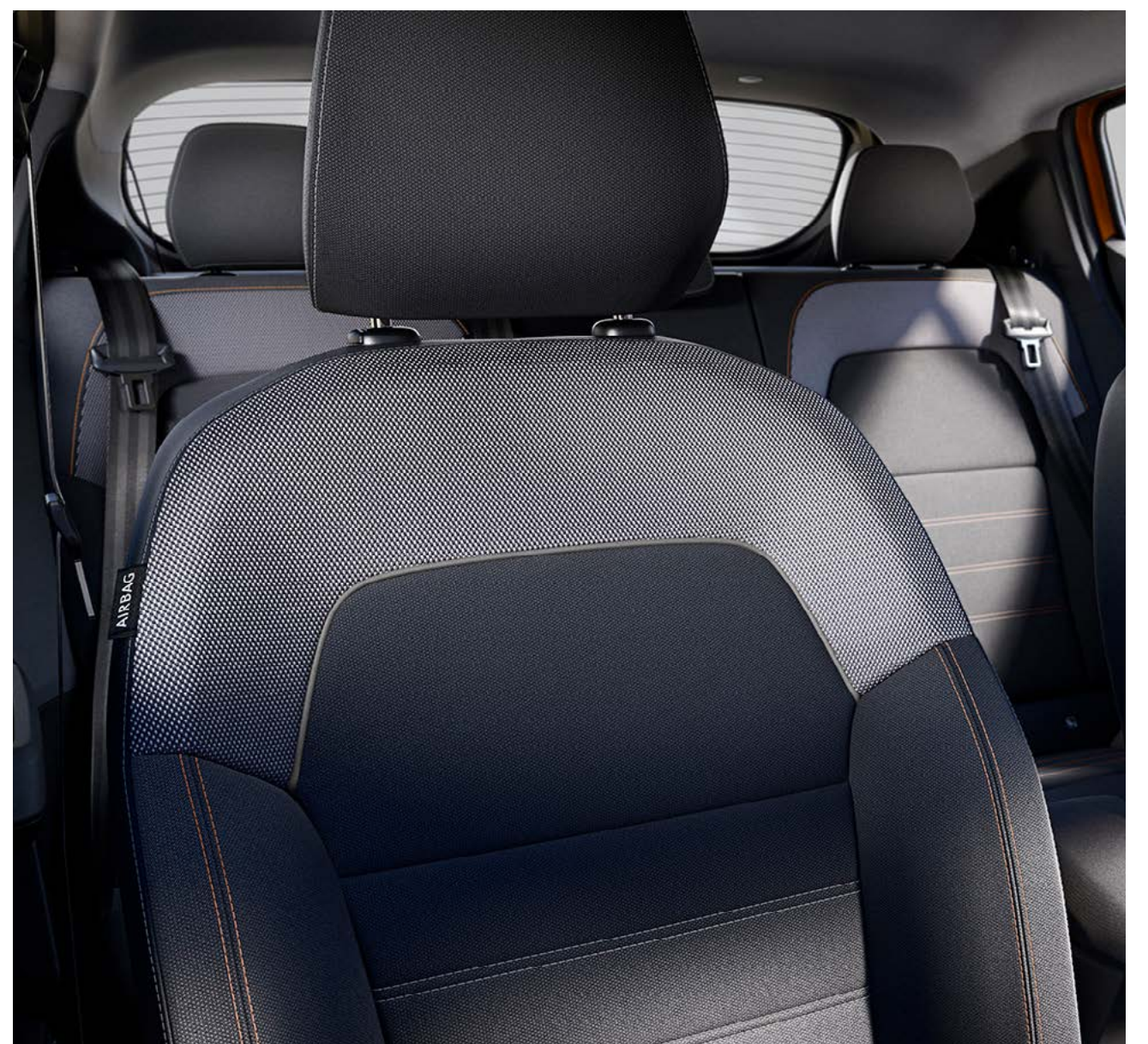

### MAIN EQUIPMENT EXPRESSION = ESSENTIAL +

#### EXTERNAL APPEARANCE

- Body tone exterior door handles
- Body-tone door mirrors
- Specific decal on front doors
- Side protection stickers

#### INTERIOR DESIGN

- Fog Grey air vent surrounds with orange centre
- Steel Grey interior door handles
- Fabric lining on the dashboard and front door armrests
- Soft feel adjustable for height and depth steering wheel

#### VISIBILITY

- Front fog lights
- Electrically adjustable door mirrors

#### COMFORT

- 4 electric windows, with driver's side one-touch control
- Keyless entry
- Automatic windscreen wipers

#### ACTIVE AND PASSIVE SAFETY

- Rear-parking sensor and reversing camera

#### MULTIMEDIA AND AUDIO

- Media Display with Android Auto™ and Apple CarPlay™ compatibility with smartphone replication, Bluetooth® connection, DAB radio with 8" touchscreen and 4 speakers, 1 USB-C socket and 1 USB-A socket

#### OPTIONS

- Metallic or special paint
- Spare wheel (Not available on TCe 100 Bi-Fuel versions)

## EXTREME



### MAIN EQUIPMENT EXTREME = EXPRESSION+

#### EXTERNAL APPEARANCE

- Specific outdoor design with door protectors and decals with topographic design
- Copper finish: exterior door mirrors, "Stepway" inscription on roof bars, decorative trim on fog lights
- 16" Mahalia black alloy wheels
- Shark fin aerial

#### INTERIOR DESIGN

- EXTREME specific upholstery with washable TEP MicroCloud fabric, with Copper stitching and embossed Dacia logo
- Copper decoration: decorative strips on the door panels
- Washable TEP MicroCloud fabric coating on the dashboard and on the front door armrests
- Front + rear rubber floor mats with topographic patterns
- Door sills with topographic patterns

#### ACTIVE AND PASSIVE SAFETY

- Blind spot warning
- Front and rear parking sensors with reversing camera

#### DRIVING AND CONTROL INSTRUMENTS

- Extended Grip function

#### COMFORT

- Automatic heating and air conditioning system
- Modular boot with twin-level floor
- Electric parking brake and high central armrest with storage
- Rear USB-C socket
- Heated front seats

#### MULTIMEDIA AND AUDIO

- Removable phone holder
- Media Nav with inbuilt navigation, Android Auto™ and Apple CarPlay™ compatibility with smartphone replication, Bluetooth® connection, DAB radio with 8" touchscreen and 6 speakers, 1 USB-C socket and 1 USB-A socket

#### OPTIONS

- Metallic paint
- Spare wheel (Not available on TCe 100 Bi-Fuel versions)

# ACCESSORY PACKS

## STYLE PACK (ESSENTIAL & EXPRESSION)

£375 inc. fitting



Roof spoiler



Shark fin aerial



Illuminated door sills

## PROTECTION PACK (ESSENTIAL)

£285 inc. fitting



Front & rear lower door protectors



Front & rear mud guards



Boot mat

Available for Expression & Extreme versions:  
Mud guards & boot mat £172 inc. fitting

## STORAGE PACK

£122



Magnetic phone holder

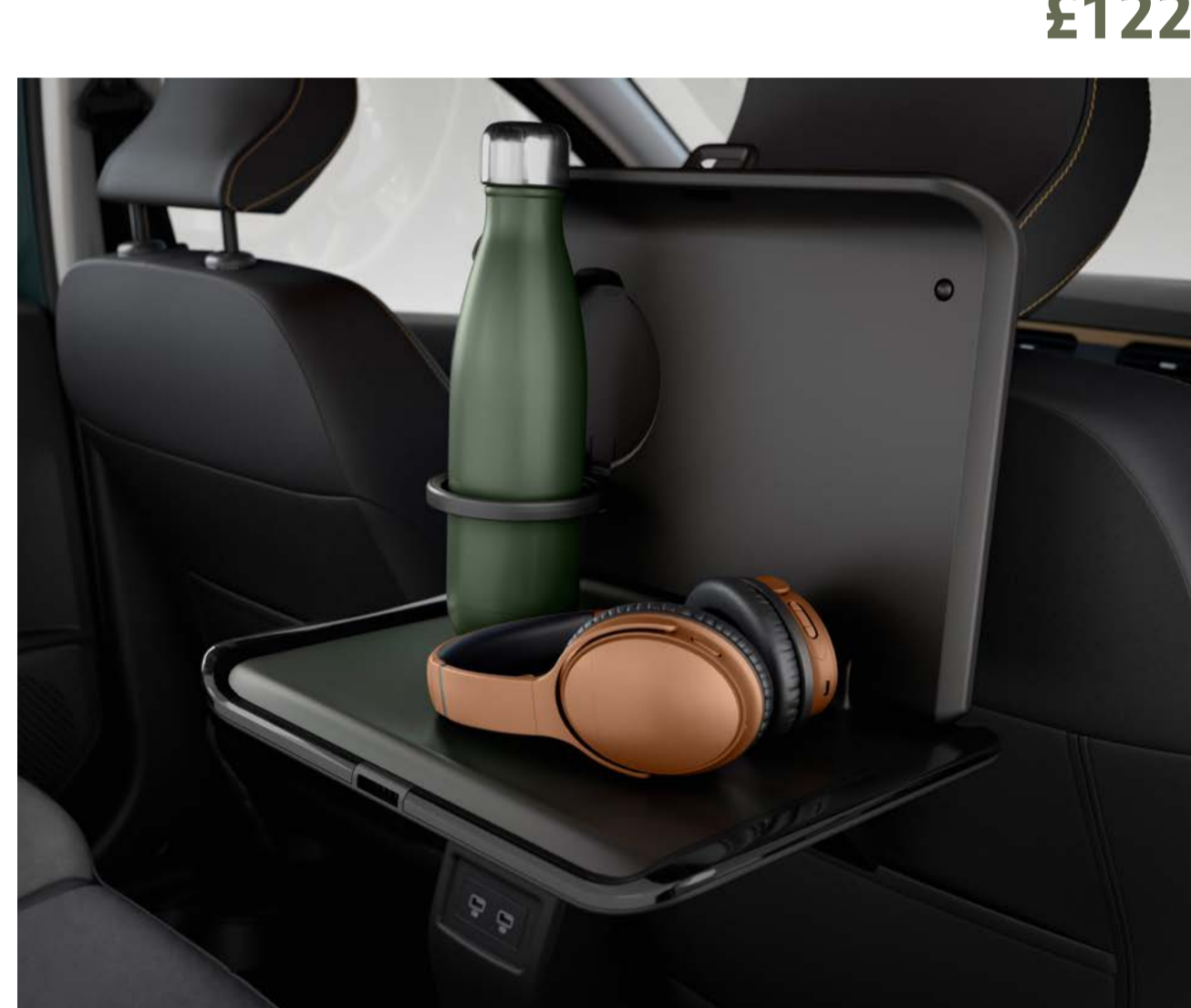

Rear tray table & fixings

Storage pack + available with 2 x rear tray tables & fixings £224

## TOURING PACK

£459



Roof bars



Roof box 400L

## DASH CAM PACK

£329 inc. fitting



Front and rear dashcam

## CYCLE PACK

£430



Roof bars



2 x bike carriers for roof

## TOW BARS



Swan neck towbar 13 pin

Removable towbar 13 pin

£579 inc. fitting

£645 inc. fitting

## PREMIUM DELIVERY PACKS

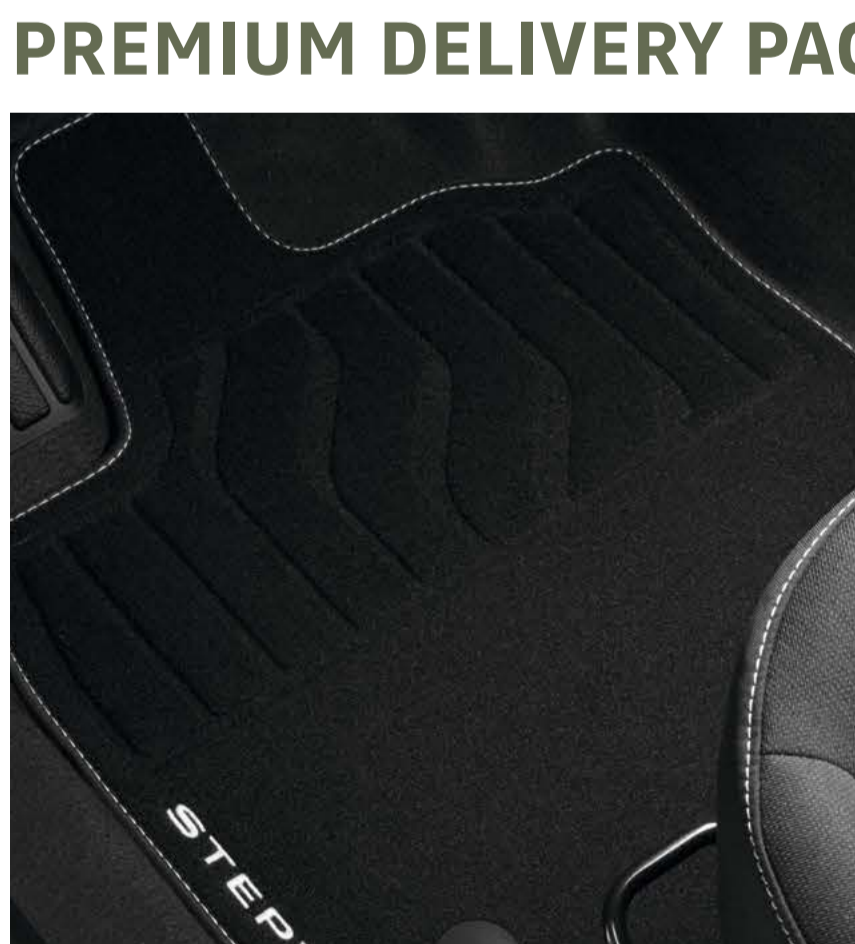

Premium mats



Safety kit

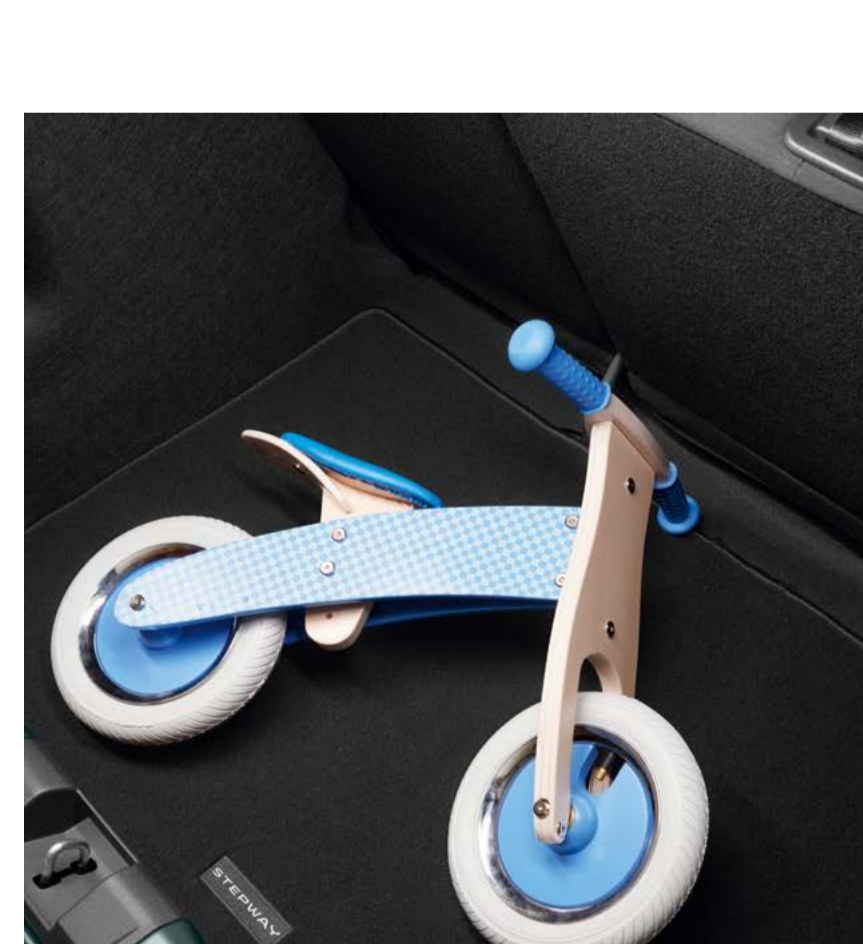

Textile boot mat

## PREMIUM DELIVERY PACK

£95

Premium mats

Safety kit

## PREMIUM DELIVERY PACK+

£160

Premium mats

Safety kit

Textile boot mat

## SPARE WHEEL KIT

£290



All accessories purchased prior to vehicle registration come with a 3 year manufacturers warranty  
Accessories are fitted post production and may have an impact on WLTP fuel (actual) consumption and CO<sub>2</sub> figures

[DOWNLOAD THE ACCESSORIES BROCHURE](#)



# ENGINES

	TCe 90	TCe 90 CVT	ECO-G 100	TCE 110
<b>ENGINES</b>				
Fiscal rating (CV) (France)	5	5	5	5
Fuel	Unleaded fuel (E10)	Unleaded fuel (E10)	Unleaded fuel (E10)/ LPG	Unleaded fuel (E10)
Max. power kW CEE (hp) at an engine speed of (rpm)	67 at 4,600-5,000	67 at 4,500-5,000	LPG mode: 74 at 4,600-5,000 Petrol Mode: 67 at 4,800-5,000	81 at 5,000-5,250
Max. torque Nm CEE (m.kg) at an engine speed of (rpm)	160 at 2,200-3,750	142 at 1,750-3,750	LPG mode: 170 at 2,000-3,500 Petrol Mode: 160 at 2,100-3,750	200 at 2,900-3,500
Gearbox type	Manual 6-speed	Auto-CVT	Manual 6-speed	Manual 6-speed
Type of Injection	Turbo indirect injection			
Capacity (cm <sup>3</sup> )	999			
Number of cylinders/valves	3/12			
Emission control standard	Euro 6 DFull			

## CHASSIS AND STEERING

Tyre dimensions	205/60 R16 92H			
Steering - Turning circle, kerb to kerb (m)	10.39			
Front suspension	Pseudo McPherson with lower wishbone, spiral spring suspension with telescopic hydraulic shock absorbers and anti-roll bar			
Rear suspension	Semi-rigid axle with anti-roll bar spring suspension and telescopic hydraulic shock absorbers			

## PERFORMANCE

	TCe 90	TCe 90 CVT	LPG	Petrol	TCE 110
Maximum speed (mph)	107	101	108	110	112
0-62 mph (s)	12	14.2	11.9		10
Mid-range acceleration: 50 mph - 75 mph (s) in 4 <sup>th</sup>	10.3	12.6	10.0	10.2	7.7
5 <sup>th</sup>	14.6		13.9	14.4	10.7
6 <sup>th</sup>	22.6		20.6	21.9	17.1

## FUEL CONSUMPTION AND EMISSIONS<sup>(1)</sup>

Approval protocol	WLTP <sup>(2)</sup>				
Fuel tank capacity (l)	50	50	Petrol: 50 LPG: 40		50
			LPG	Petrol	
CO <sub>2</sub> emissions (g/km) Best Case - Worst Case	125/127	140	113/114	130/131	125
Fuel consumption during combined cycle (mpg) Best Case - Worst Case	50.4/51.4	45.6	39.8/40.4	48.7/49.6	51.5

## VOLUMES AND WEIGHTS

	TCe 90		TCe 90 CVT	ECO-G 100		TCE 110
	Essential	Expression/Extreme	Extreme	Essential	Expression/ Extreme	Extreme
Minimum kerb weight	1,076	1,095/1,097	1,122	1,132	1,150/1,153	1,107
Maximum kerb weight	1,120	1,135/1,137	1,161	1,160	1,176/1,177	1,146
Gross train weight (GTW)	2,665	2,680	2,705	2,702	2,720	2,690
Maximum permissible laden weight (MPLW)	1,565	1,580	1,605	1,605	1,620	1,590
Max. braked towing weight	1,100	1,100	1,100	1,100	1,100	1,100

(1) Official consumption and emissions according to applicable regulations. (2) WLTP (Worldwide Harmonised Light Vehicle Test Procedures): this new protocol provides results much closer to those found in daily use compared with the NEDC protocol. Fuel consumption and CO<sub>2</sub> emissions are certified using a standard, regulated method. This method is identical for all manufacturers and enables vehicles to be compared.

[BUILD YOURS](#)

[BACK TO CONTENTS](#)

# EQUIPMENT AND OPTIONS

	ESSENTIAL	EXPRESSION	EXTREME
<b>EXTERNAL APPEARANCE</b>			
LED brand light	•	•	•
LED automatic daytime running lights	•	•	•
Grille	Black	Black	Black
Grille Logo «Stepway» inscription	White	White	White
Dacia rear lettering	White	White	Copper
Front/rear bumpers	Body-coloured	Body-coloured	Body-coloured
Megalith Grey front/rear skid plates	•	•	•
Side protection stickers/snorkel-type sticker	-	•/-	Topographic pattern
Exterior door handles	Black	Body-coloured	Body-coloured
Door mirrors	Black	Body-coloured	Copper
Longitudinal roof bars (Megalith Grey)	•	-	-
Modular roof bars	-	•	•
16" Atara Dark Flexwheels	•	•	-
16" Mahalia black alloy wheels	-	-	•
Shark fin antenna	-	-	•
White expression decal on front doors	-	•	-
<b>INTERIOR APPEARANCE</b>			
Centre of air vents	Copper and white sliders	Copper and white sliders	Copper and white sliders
Air vent surrounds	Black	Fog Grey	Fog Grey
Interior door handles	Black	Steel Grey	Steel Grey
Upholstery on the dashboard and front door armrests/trim on the front door panels	-/-	Fabric / Fabric	MicroCloud Fabric
1/3- 2/3 split-fold rear bench seatback	•	•	•
Soft feel steering wheel	-	•	•
Essential & Expression upholstery	•	•	-
Extreme MicroCloud plastic-coated fabric upholstery	-	-	•
<b>ACTIVE AND PASSIVE SAFETY</b>			
My Safety button to manage driver-assistance systems	•	•	•
Anti-lock Braking System (ABS) and Emergency Brake Assist (EBA)	•	•	•
Automatic emergency braking (AEBS) with pedestrian/cyclist detection	•	•	•
Electronic Stability Control (ESC) with Hill Start Assist (HSA)	•	•	•
Emergency call (E-call)	•	•	•
Event (accident) data recorder	•	•	•
Alcohol Immobiliser predisposition	•	•	•
Traffic sign recognition with speed alert / Intelligent Speed Assist (ISA)	•	•	•
Lane Departure Warning(LDW) + Lane Keep Assist (LKA)	•	•	•
Driver attention alert	•	•	•
Front / rear "Rescue Code®" QR Code	•	•	•
Driver's front airbag/passenger's front airbag can be deactivated	•/•	•/•	•/•
Shoulder and curtain side airbags	•	•	•
Rear parking sensors	•	•	•
Rear view camera	-	•	•
Front parking sensors	-	-	•
Blind spot warning	-	-	•
Electric parking brake with high central armrest with storage compartment, 1 12V socket and 1 USB-C socket in the rear	-	-	•
Tyre pressure monitor	•	•	•
Spare wheel + jack (except TCe 100 Bi-Fuel)	o	o	o
Tyre inflation kit	•	•	•
Isofix child seat mounting system on rear side seats	•	•	•
180kmh/112mph speed limiter	•	•	•

-: not available; •: available as standard; o: available as an option.

# EQUIPMENT AND OPTIONS (CONTINUED)

	ESSENTIAL	EXPRESSION	EXTREME
<b>DRIVING AND CONTROL INSTRUMENTS</b>			
Electrical power-assisted steering	•	•	•
Stop & Start	•	•	•
On-board computer: distance travelled, average speed, range, average consumption (including for LPG)	•	•	•
Rain and light sensors	•	•	•
Cruise control/Speed limiter with audible warning	•	•	•
Extended Grip	-	-	•
<b>VISIBILITY</b>			
Front fog lights	-	•	•
Door mirrors manually adjustable from inside	•	-	-
Electrically adjustable door mirrors	-	•	•
<b>COMFORT</b>			
Manual heating and air conditioning system	•	•	-
Automatic heating and air conditioning system	-	-	•
Automatic screen wipers	-	•	•
Electric door locking with radio frequency remote control	•	•	•
Automatic locking of doors when in motion	•	•	•
Keyless Entry	-	•	•
Front electric driver and passenger windows	•	•	•
One-touch driver-seat window control (with anti-trapping function), non one-touch passenger side	-	•	•
Electric rear windows	-	•	•
Height- and reach-adjustable steering wheel	•/-	•/•	•/•
Front ceiling light	•	•	•
1 x 12V socket in the front	•	•	•
Heated front seats	-	-	•
Modular boot with twin-level floor	-	-	•
<b>MULTIMEDIA &amp; AUDIO</b>			
New Media Control: DAB radio with steering wheel controls, jack socket and 1 USB-C socket, 2 speakers, Bluetooth® telephone system with side controls on the steering wheel, fixed smartphone holder on the dashboard, new Dacia Media Control smartphone app	•	-	-
Media Display: multimedia system with 8" touchscreen, DAB digital radio, smartphone mirroring via USB cable, Bluetooth® connection, side controls on steering wheel, 4 speakers, 1 USB-C socket and 1 USB-A socket	-	•	-
Media Nav: multimedia system with 8" touchscreen, navigation with Map Care (map of Western Europe or Eastern Europe [depending on country] + 6 free updates for 3 years), DAB digital radio, smartphone replication via USB cable or wireless via Wi-Fi, Bluetooth® connection, side controls on steering wheel, 6 speakers (4 speakers + 2 tweeters), 1 USB-C socket and 1 USB-A socket	-	-	•
Removable phone holder	-	•	•

-: not available; •: available as standard; o: available as an option.

[BUILD YOURS](#)

[BACK TO CONTENTS](#)

# PRICING

	CO <sub>2</sub> G/KM WLTP	FUEL TYPE	COMBINED FUEL CONSUMPTION (MPG) - WLTP	BHP	BENEFIT IN KIND	VED YEAR 1	BASIC PRICE	VAT 20%	TOTAL RETAIL PRICE	ON THE ROAD PRICE*
<b>ESSENTIAL</b>										
TCe 90 MY24	125	Petrol	51.4 (5.5)	90	30%	£220	£12,020.83	£2,404.17	£14,425.00	£15,295
TCe 100 Bi-Fuel MY24	130/113	Petrol/LPG	49.6 (5.7) - 40.4 (7.0)	100	31%	£210	£12,029.17	£2,405.83	£14,435.00	£15,295
<b>EXPRESSION</b>										
TCe 90 MY24	126	Petrol	51.4 (5.5)	90	31%	£220	£12,854.17	£2,570.83	£15,425.00	£16,295
TCe 100 Bi-Fuel MY24	130/113	Petrol/LPG	48.7 (5.8) - 40.4 (7.0)	100	31%	£210	£12,862.50	£2,572.50	£15,435.00	£16,295
<b>EXTREME</b>										
TCe 90 MY24	127	Petrol	50.4 (5.6)	90	30%	£220	£13,979.17	£2,795.83	£16,775.00	£17,645
TCe 90 Auto MY24	140	Petrol	45.6 (6.2)	90	33%	£270	£15,187.50	£3,037.50	£18,225.00	£19,145
TCe 100 Bi-Fuel MY24	131/114	Petrol/LPG	48.7 (5.8) - 39.8 (7.1)	100	31%	£260	£13,945.83	£2,789.17	£16,735.00	£17,645
TCe 110 MY24	125	Petrol	51.4 (5.5)	110	30%	£220	£14,812.50	£2,962.50	£17,775.00	£18,645

\* "On the Road" price includes delivery to the dealer premises, number plates, 12 months government road fund license (depending on CO<sub>2</sub> emissions) and First Registration Fee at £55.

# OPTIONS

	ESSENTIAL	EXPRESSION	EXTREME	BASIC PRICE	VAT 20%	TOTAL RETAIL PRICE
Metallic & opaque paint	<input type="radio"/>	<input type="radio"/>	<input type="radio"/>	£541.67	£108.33	£650
Spare Wheel (excluding Bi-Fuel)	<input type="radio"/>	<input type="radio"/>	<input type="radio"/>	£250.00	£50.00	£300

# ENJOY THE RIDE WITH DACIA ZEN



## DACIA ZEN ENABLES OWNERS TO ENJOY UP TO SEVEN YEARS OF WARRANTY

- Brand new Dacia Zen warranty offers Dacia owners up to seven years of cover
- It's applicable to all Dacia models under six years old which have covered less than 75,000 miles
- Warranty is complimentary with every service completed at an official Dacia retailer
- Dacia Zen is available to owners of qualifying vehicles even if their Dacia has been previously serviced outside of the official Dacia retail network

## WHO BETTER TO LOOK AFTER YOUR DACIA, THAN DACIA?

Are you the proud owner of a new or used Dacia? If your vehicle is less than 6 years old and has covered less than 75,000 miles you can get up to 7 years warranty with Dacia\*

It's simple. Get your Dacia serviced by one of our expert retailers after your standard 3-year warranty expires and enjoy a Dacia ZEN warranty for a year or 18,000 miles (whichever comes sooner).

Enjoy the ride with Dacia ZEN.



Your Dacia is less than 6-years old and has done less than 75,000 miles



Have your next manufacturer service carried out in our retailer network



Get an additional 1-year of warranty\*

\*Warranty activated following service at participating Dacia Dealers. Valid for 1 year or 18,000 miles (whichever comes first). Vehicles over 6 years old or 75,000 miles not eligible. Full T&Cs apply.

[BOOK A SERVICE](#)

# WE'VE GOT YOU COVERED

You might think our shockingly affordable prices mean our cars aren't made to last. Actually, the Dacia range is one tough cookie. To prove it, you get a 3-year\* warranty (or 60,000 miles, if you reach that first). This means we will replace any part which has been deemed by a Dacia approved dealer to be defective due to a manufacturing fault, free of charge. To keep the good times rolling, you can extend your warranty up to 7 years for a great price. We also give you a 2-year paintwork and 6-year anti-corrosion warranty, so you can kick back knowing that your Dacia will stay looking good-as-new for years to come.

## ROADSIDE ASSISTANCE

Although our cars are built for plain sailing, you can rely on us if you have a breakdown – 24/7 365, wherever you are in the UK or Northern Ireland. This offer also stands for the first 3 years/60,000 miles $\Delta$  after you buy your new Dacia.

## DACIA CAR INSURANCE 1

Dacia Insurance has been specifically created to provide superb protection for you and your car. Unlike most other UK insurers, in the event of an accident, your Dacia will be repaired at a Dacia Approved Bodyshop using only Dacia approved parts and approved repair methods. This maintains your Dacia's safety rating, protects its resale value and helps to maintain its Dacia warranty $\wedge$ . Dacia Insurance also offers a courtesy car for the duration of a repair at a Dacia Approved Bodyshop.

**Dacia car insurance: 0330 102 7795 [www.daciacarinsurance.co.uk](http://www.daciacarinsurance.co.uk)**

Lines are open Mon - Thurs 8.30am - 7pm, Fri 9am - 6pm, Sat 9am - 5pm

## SERVICING

Dacia Service Plans are the ultimate hassle free way to take care of your vehicle. Depending on the Service plan you purchase (grid below) your servicing needs are covered and you benefit from;

- Inflation Proof Servicing – You know exactly what you'll pay and there are no hidden costs
- Peace of Mind – No matter where life takes you, we'll be there in over 5000 workshops across Europe
- Dacia Expertise & Quality – Our highly trained technicians know your Dacia inside out

The Dacia Service Plan contains Dacia services in-line with the manufacturer's service schedule, plus comes with a complimentary vehicle health check to ensure your Dacia is in the best condition possible.

SERVICE PLAN $\wedge$	Monthly payments
3 years / 30,000 miles Service Plan	£13.99 per month
3 years / 45,000 miles Service Plan	£21.99 per month
4 years / 48,000 miles Service Plan + 1 MOT	£19.99 per month
4 years / 60,000 miles Service Plan +1 MOT	£23.99 per month

## SERVICE INTERVALS $\diamond$

Annual servicing **OR** servicing at 18,000 miles (whichever comes first)

Service Schedule $\diamond$	Year 1	Year 2	Year 3
	Change Cabin Filter	Change Oil + Oil Filter	Change Cabin filter + Brake Fluid
	Year 4	Year 5	Year 6
	Change Oil + Oil filter + Air filter (36k miles) + Spark Plugs (36k miles)	Change Cabin filter + Coolant (90k miles)	Change Oil + Oil Filter + Brake Fluid + Accessory Belt (90k miles)

\*Dacia warranty ends when you reach the age or mileage limit (whichever comes first), from date of registration. Subject to status, terms and conditions apply. For full Dacia Extended Warranty Terms and Conditions visit [www.dacia.co.uk/warranty-and-assistance/warranty](http://www.dacia.co.uk/warranty-and-assistance/warranty)

$\Delta$ Roadside assistance for the first 3 year / 60,000 miles, which ever is reached first, from date of registration. For full Terms and Conditions visit [www.dacia.co.uk/warranty-and-assistance/warranty](http://www.dacia.co.uk/warranty-and-assistance/warranty)

$\dagger$  Dacia Extended Warranties are available to purchase up to end of manufacturer warranty. For full Dacia Extended Warranty Terms and Conditions visit [www.dacia.co.uk/warranty-and-assistance/warranty](http://www.dacia.co.uk/warranty-and-assistance/warranty)

$\wedge$  The Service plan offer is available for eligible retail vehicles only and valid at participating dealers only. Vehicles must be ordered between 2 July to 30 September and registered by 31 December 2024. The Dacia Service plan covers the manufacturer's minimum maintenance programme requirements for the term of the Service plan purchased (refer to the Warranty and Service sheet in the Handover Document wallet for details). The plan ends when you reach the age or mileage limit (whichever comes first). Services must be carried out in line with the manufacturer's minimum maintenance programme requirements and servicing intervals within +/- 1 month or 1,000 miles of the service interval and can only be carried out at a Dacia Approved outlet. Service plans do not cover wear and tear items such as (but not limited to) tyres, wiper blades or brakes. For Service plan full Terms & Conditions visit [www.dacia.co.uk/services-and-finance/service-plan](http://www.dacia.co.uk/services-and-finance/service-plan). Cannot be part exchanged, refunded or transferred.

$\diamond$  The service schedule and intervals are specific to the version and derivative of vehicle. Check with your Dacia retailer to confirm the service schedule / intervals as the above is an indicative guideline.

1 Dacia Insurance is arranged and administered by Verex Insurance Services Ltd, which is registered in England and Wales No. 05686831 at Batchworth House, Church Street, Rickmansworth, Herts, WD3 1JE and authorised and regulated by the Financial Conduct Authority, No. 487185. Verex Insurance Services Ltd arranges policies from a panel of insurers, details are available on request.

$\wedge$ If your insurer uses non-approved parts which subsequently fail, they may not be covered under your manufacturer's warranty.

# DIMENSIONS

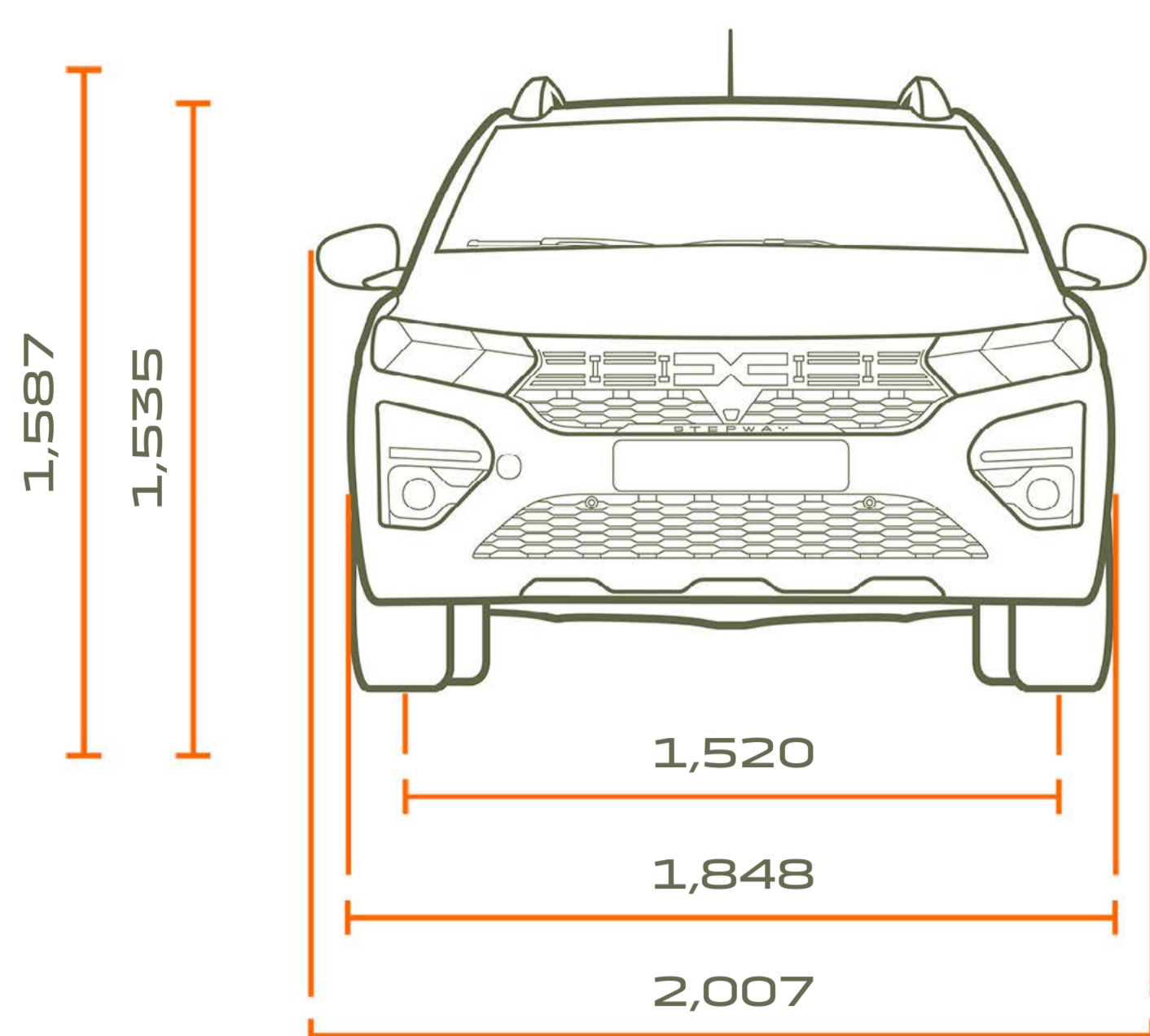

**FRONT VIEW**

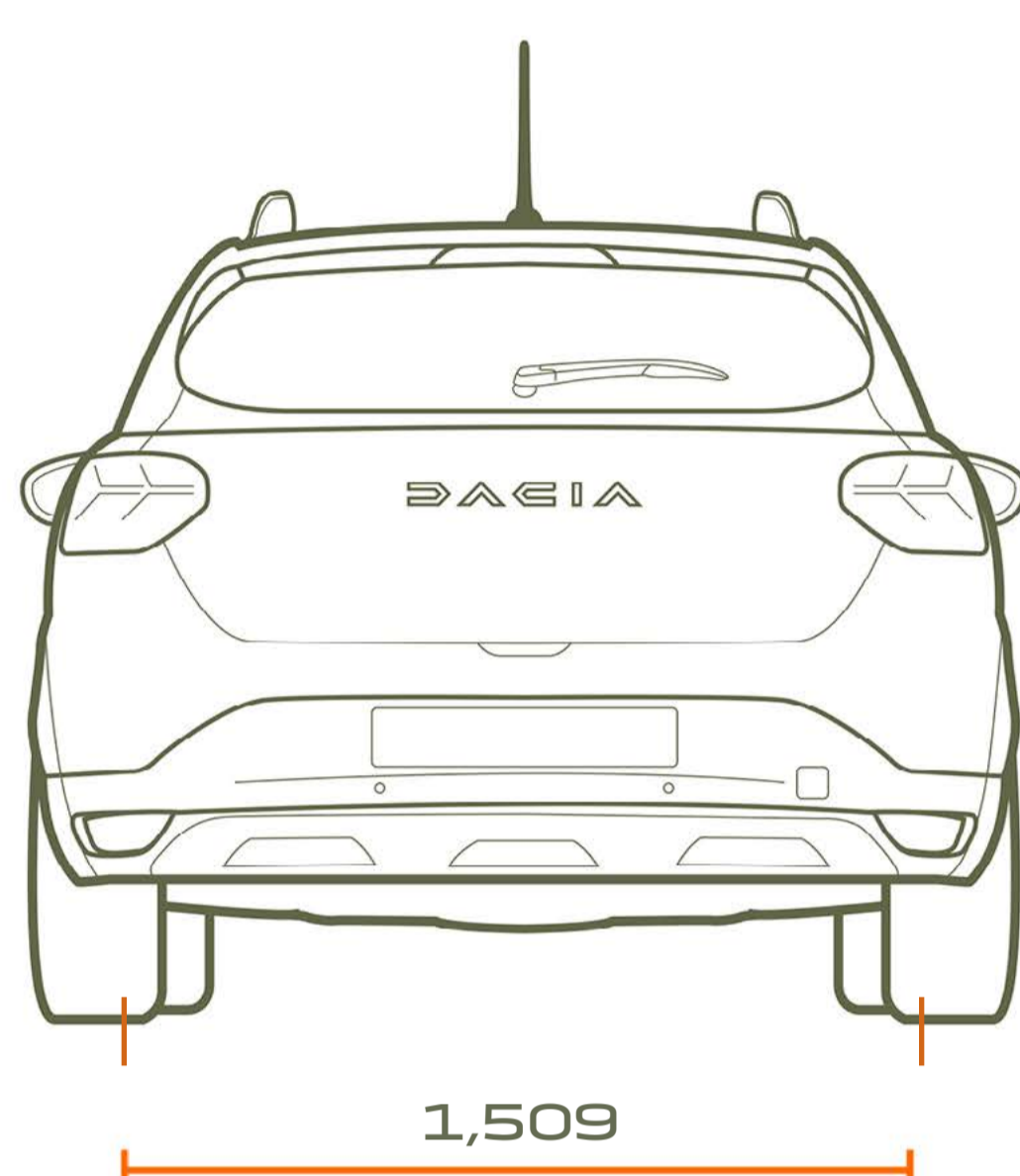

**REAR VIEW**

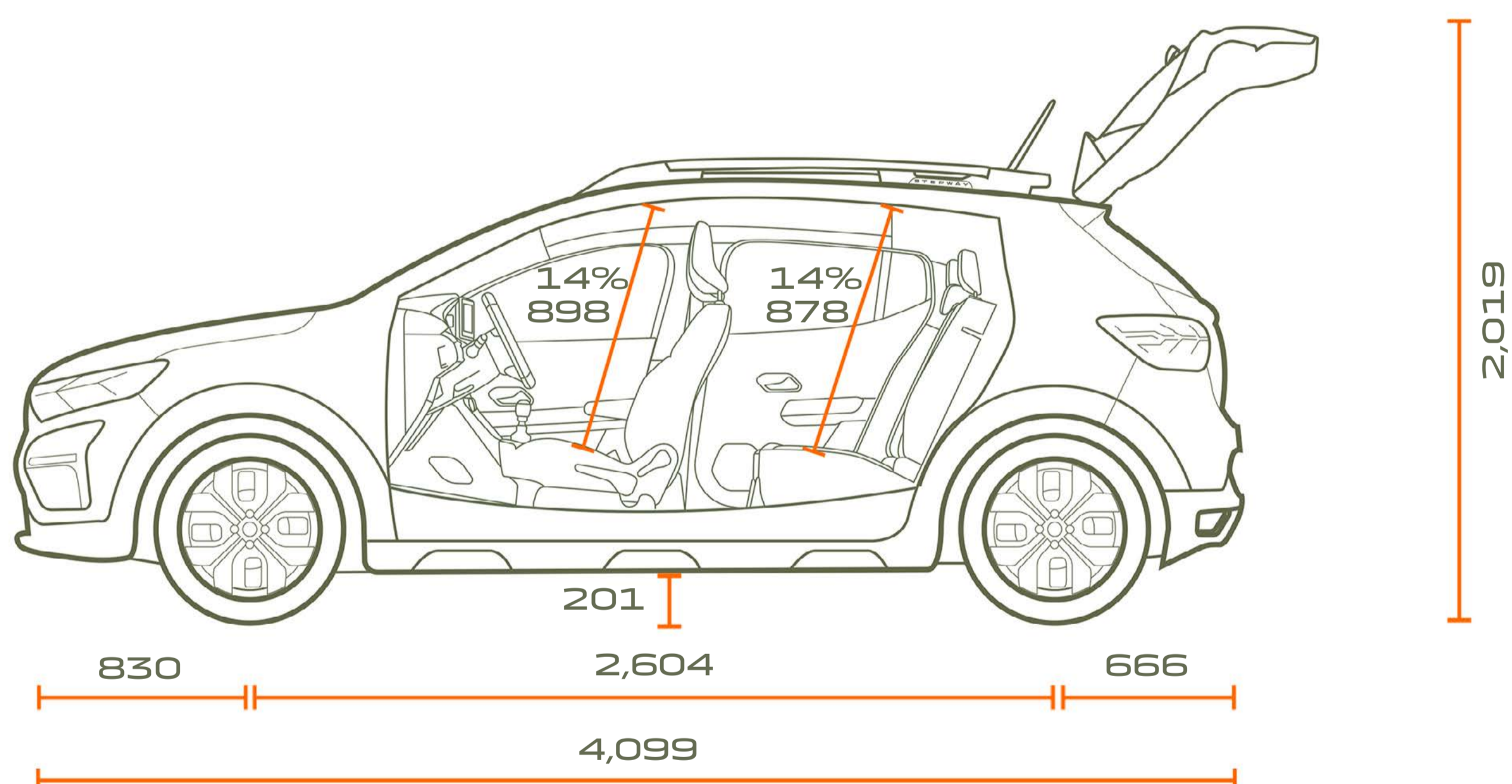

**SIDE-FACE VIEW**

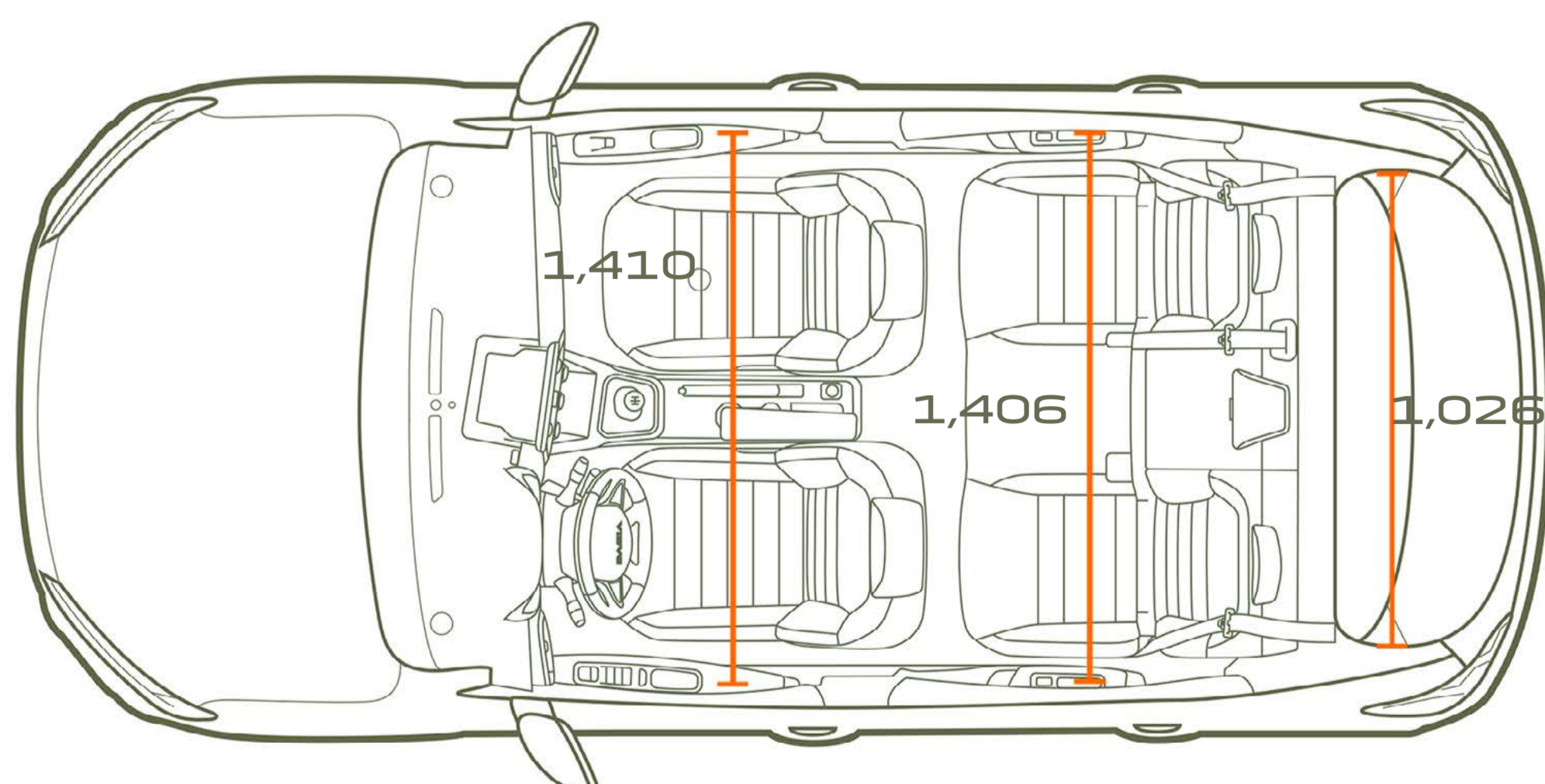

**TOP VIEW**

**BOOT VOLUME**  
(IN DM<sup>3</sup> - VDA STANDARD / LITRES)

Minimum boot volume(ISO 3832 standard)	328/410
Maximum boot volume (ISO 3832 standard)	1,108/1,455
Volume under false floor (ISO 3832)	78

# AN UNBELIEVABLE SUCCESS STORY

At Dacia, we offer practical, reliable vehicles that offer the best value for money. Our models have a distinctive style without unnecessary frills, equipped with the most reliable, tried-and-tested technologies, all at an unbeatable price. Since launching in the UK, we have changed the rules of the game and disrupted the car market.





# TO GO FURTHER

**BUILD YOURS**

**BOOK A TEST DRIVE**

**FIND YOUR DEALERSHIP**

Go to the DACIA social media accounts:



Every precaution has been taken to ensure that the contents of this brochure were accurate and up-to-date at the time of publication. This document was created using pre-production models and prototypes. In line with its policy of continuous product improvement, Dacia reserves the right to modify the specifications, vehicles and accessories described and featured at any time. Any such modifications are communicated to Dacia dealers as quickly as possible. Depending on the country of sale, versions may differ and some equipment may be unavailable (standard, optional or accessories). Please consult your Dacia brand representative for the latest information. For reasons to do with the medium, the colours featured in this document may differ slightly from those of the actual paintwork or interior trim. All rights reserved. Reproduction in any format and by any means of all or part of this publication is prohibited without prior written authorisation from Dacia.

Dacia recommends 

PUBLICIS – PHOTO CREDITS: BAM; A. BERNIER; GETTY IMAGES; MCMURPHY; Shutterstock; © RENAULT MARKETING 3D-COMMERCE – JULY 2024